



# GARAGE DOOR OPENER 8FT EXTENSION KIT MODEL: 24115

www.deckogdo.com  
1-877-GDO-4402  
1-877-436-4402  
2301 Traffic St. NE  
Minneapolis, MN 55413

**⚠ WARNING**

To prevent **SERIOUS INJURY** or **DEATH**:

- DO NOT connect power until instructed.
- CLOSE the door before installation.



**Kit Inventory**

 x 1

Extended Rail (39-2/5 inch) — Extended Middle Segment

 x 1

Extended Chain Segment (approx. 17-1/3 inch)

 x 1

Extended Cable (approx. 121-1/2 inch)

 x 2

Master Link Set (Including 1x spare set)

**Components Required from Opener Inventory**

 Rail — Header Segment

 Chain

 Trolley Shaft and Cable

 Rail — Middle Segments x2

 Discard 1 Middle Segment (25-3/5 inch)

 Rail — End Segment with Trolley Stop Bolt

## STEP 1. To Assemble Rail with “Extended Middle Segment”

Please refer to “Rail and Trolley Assembly” in Owner’s Manual.

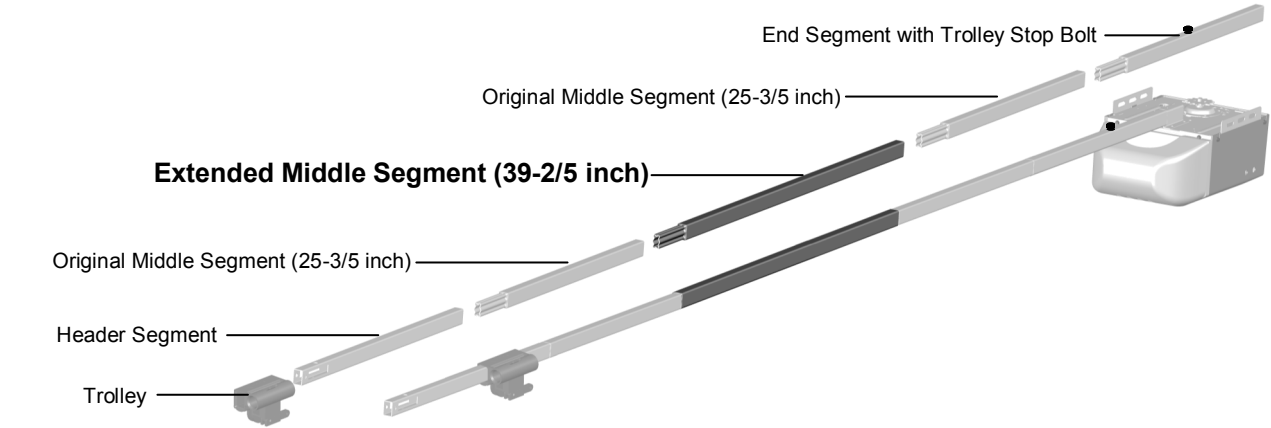

Replace ONE of the original rail Middle Segment with the “Extended Rail Segment” in the middle of rail assembly.

**⚠ WARNING**

- Discard ONLY ONE of the original MIDDLE rail segment.
- ONLY 5 pieces of rail segment should be applied. NEVER connect extra rail segments.
- The opener only services door to max. of 8 FT. height. Door with other size please call service before installation.

**Step 2. Extending the Chain**

**1. To Disconnect "Chain to Cable Connector" from the Original Chain**

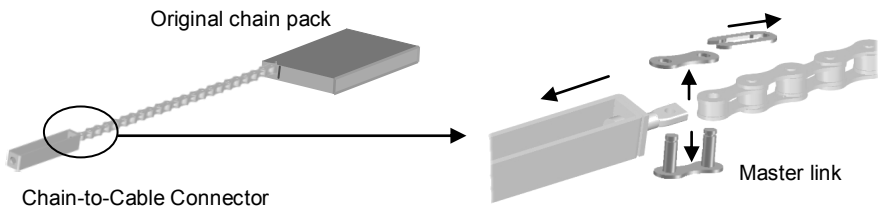

Disconnect the "Chain to Cable Connector" from the original chain by removing the master link.

Keep all the hardware in this step.

**2. To Connect "Extended Chain Segment" to Chain**

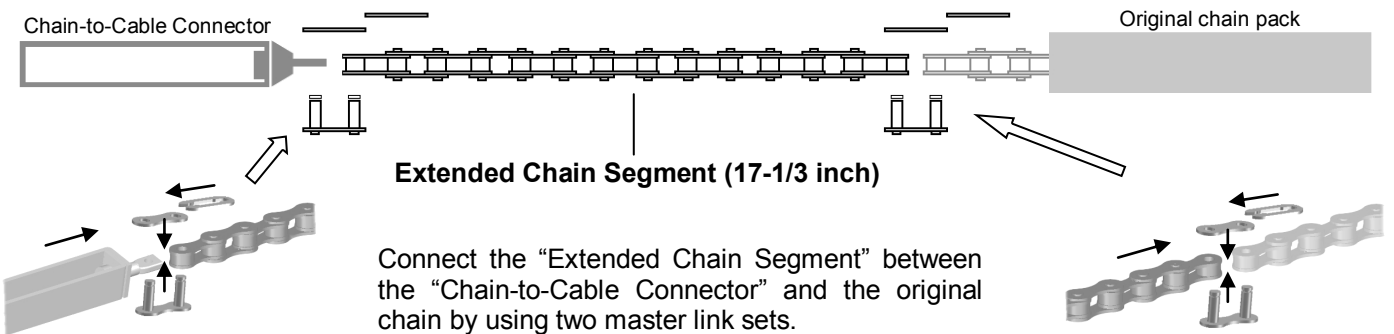

Connect the "Extended Chain Segment" between the "Chain-to-Cable Connector" and the original chain by using two master link sets.

**Step 3. Extending the Cable**

**Replace the original cable with the "Extended Cable"**

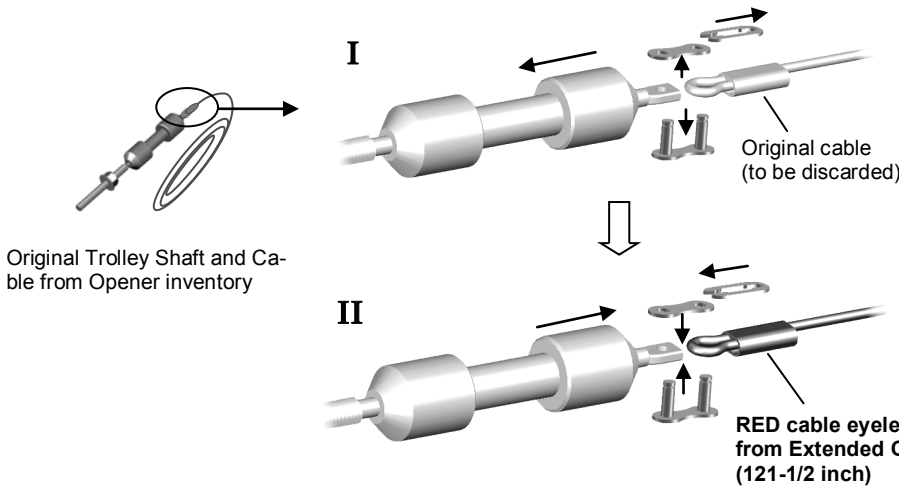

**I.** Disconnect the "Trolley Shaft" from the original cable by removing the master link.

Discard the original cable.

**II.** Align the "Trolley Shaft" to one of the RED eyelets of the "Extended Cable", connect them together using the master link set.

**Step 4. Proceeding with Installation of Opener**

The Rail Assembly Extension with has now been finished.

The Rail Assembly consists of extended rail middle segment, chain segment and cable with RED eyelets.

ONE piece of original rail middle segment and original cable are discarded.

Please proceed installation of opener starting with "Rail and Trolley Assembly" in Owner's Manual.